



McGuire Manufacturing Co., Inc.

60 Grandview Court
 P.O. Box 746 • Cheshire, CT 06410
 203-699-1801 • Fax: 203-699-1813
 www.mcguiremfg.com

PRODUCT SPECIFICATION

Part No.

PW111C16G17

**PreWrapped End Outlet
 Continuous Waste**

Job Name:

Submittal Number:

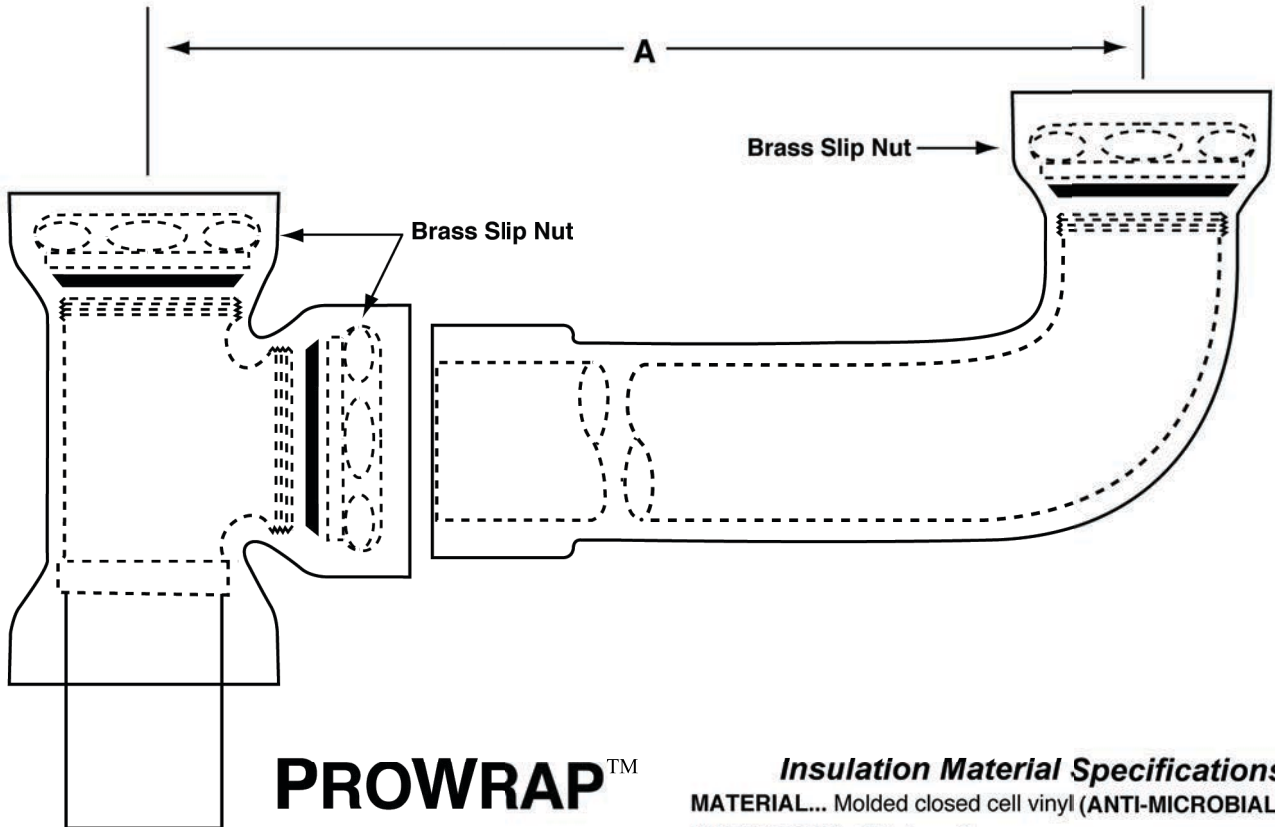

PROWRAP™

Insulation Material Specifications

MATERIAL... Molded closed cell vinyl (ANTI-MICROBIAL)

DUROMETER... 70 shore A

COLOR... Glossy White

BURNING CHARACTERISTICS...

ASTM D 635: Less than 5 sec (ATB) 10mm (AEB)

HEAT RESISTANCE...

ASTM C 177: BTU - in/hr - ft 2 - °F K Value = 1.02

FUNGAL RESISTANCE...

ASTM G - 21: (Rating*) 0 fungal growth measured

ASTM G - 22: (Rating*) 0 bacterial growth measured

***ASTM Rating - Observed Growth on Specimens**

- 0 None
- 1 Traces of Growth (less than 10%)
- 2 Light Growth (10-30%)
- 3 Medium Growth (30-60%)
- 4 Heavy Growth (60%-complete coverage)

Environmental Controls:

Paper - 4, Cork - 1, Cotton - 4, Glass - 0

MODEL NO.	DESCRIPTION	ROUGHING MEASUREMENT
		A
PW111C16G17	1-1/2" end outlet waste	16"

MADE IN USA
 U.S. PATENT

5,341,830 5,586,568
 5,904,175 5,911,237
 5,795,623 5,678,598

Specifications:

Seamless PreWrapped End Outlet Continuous Waste with cast brass tee, chrome plated 17 gauge seamless brass waste arm, brass tailpiece and brass nuts.



WARNING:

This product can expose you to chemicals including lead, which is known to the State of California to cause cancer, and birth defects or other reproductive harm. For more information go to www.P65Warnings.ca.gov.



McGuire Manufacturing Co., Inc.

60 Grandview Court
 P.O. Box 746 • Cheshire, CT 06410
 203-699-1801 • Fax: 203-699-1813
 www.mcguiremfg.com

PRODUCT SPECIFICATION

Part No.

PW113C16G17

**PreWrapped Center Outlet
 Continuous Waste**

Job Name:

Submittal Number:

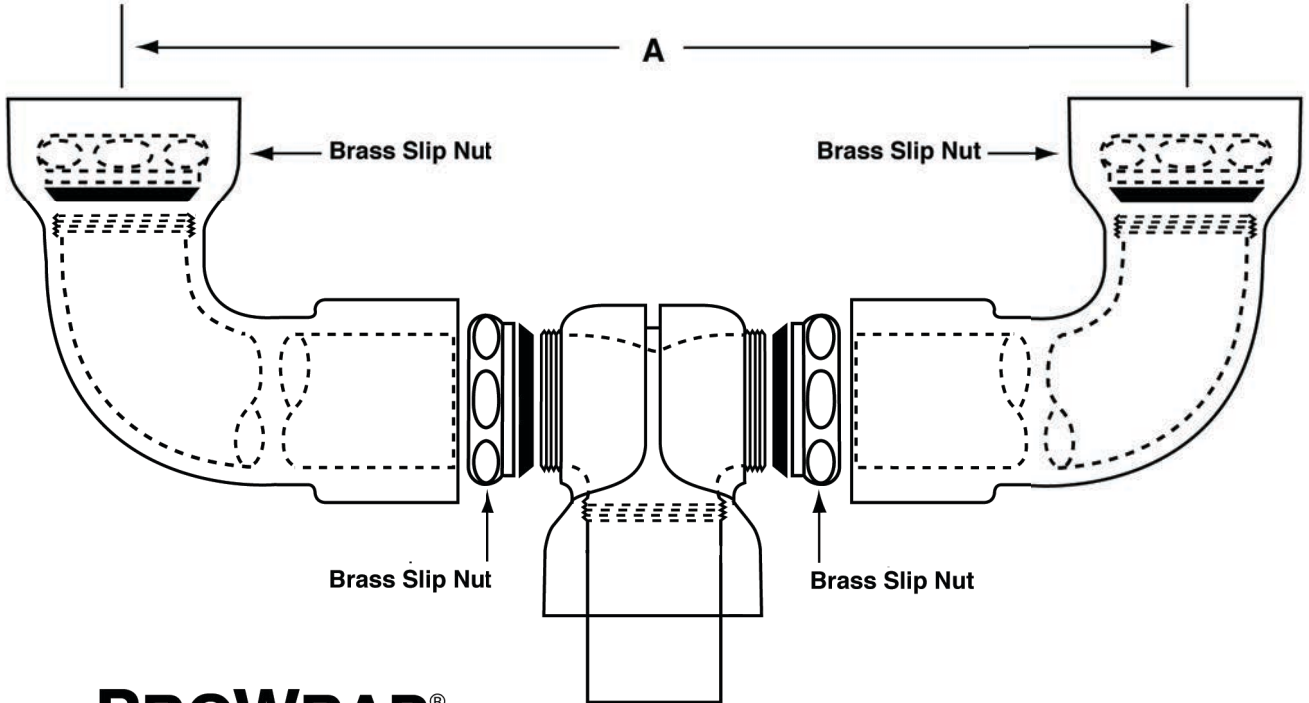

PROWRAP®

Insulation Material Specifications

MATERIAL... Molded closed cell vinyl (**ANTI-MICROBIAL**)

DUROMETER... 70 shore A

COLOR... Glossy White

BURNING CHARACTERISTICS...

ASTM D 635: Less than 5 sec (ATB) 10mm (AEB)

HEAT RESISTANCE...

ASTM C 177: BTU - in/hr - ft 2 - °F KValue = 1.02

FUNGAL RESISTANCE...

ASTM G - 21: (Rating*) 0 fungal growth measured

ASTM G - 22: (Rating*) 0 bacterial growth measured

*ASTM Rating - Observed Growth on Specimens

- 0 None
- 1 Traces of Growth (less than 10%)
- 2 Light Growth (10-30%)
- 3 Medium Growth (30-60%)
- 4 Heavy Growth (60%-complete coverage)

Environmental Controls:

Paper - 4, Cork - 1, Cotton - 4, Glass - 0

MODEL NO.	DESCRIPTION	ROUGHING MEASUREMENT
		A
PW113C16G17	1-1/2" center outlet waste	16"

MADE IN USA
 U.S. PATENT
 5,341,830 5,586,568
 5,904,175 5,911,237
 5,795,623 5,678,598

See options and accessories section for details on product variations.

Specifications:

Seamless PreWrapped Center Outlet Continuous Waste with cast brass tee, chrome plated 17 gauge seamless brass waste arms, brass tailpiece and brass nuts.



WARNING:

This product can expose you to chemicals including lead, which is known to the State of California to cause cancer, and birth defects or other reproductive harm. For more information go to www.P65Warnings.ca.gov.



McGuire Manufacturing Co., Inc.

60 Grandview Court
Cheshire, Connecticut 06410
(203) 699-1801 Fax (203) 699-1813
customerservice@mcguiremfg.com mcguiremfg.com

PRODUCT SPECIFICATION

Part No.

PW152N

Wide Top Sink Strainer with ProWrap® Tailpiece Cover

Job Name:

Submittal Number:

PROWRAP™

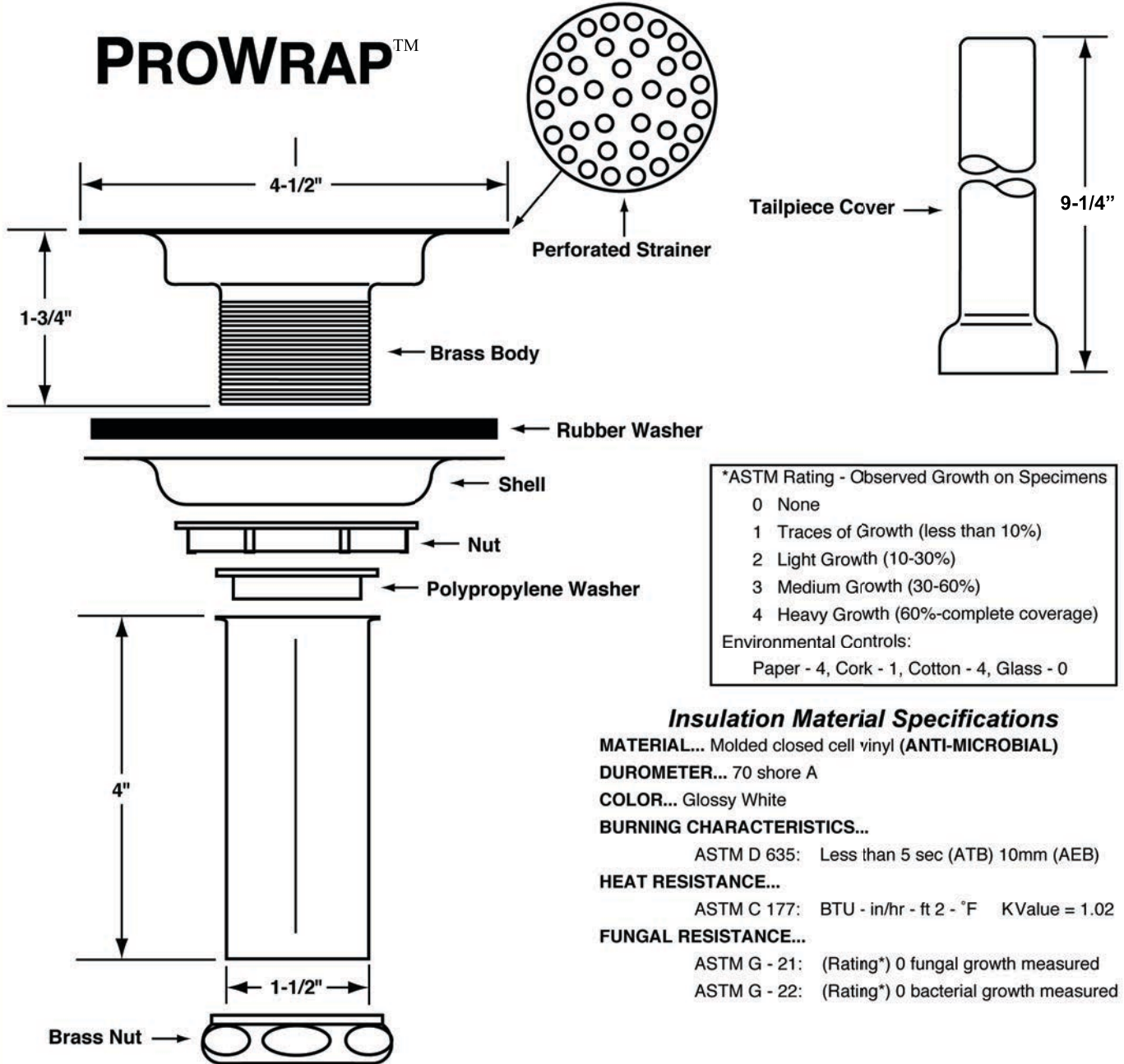

*ASTM Rating - Observed Growth on Specimens	
0	None
1	Traces of Growth (less than 10%)
2	Light Growth (10-30%)
3	Medium Growth (30-60%)
4	Heavy Growth (60%-complete coverage)
Environmental Controls:	
Paper	- 4, Cork - 1, Cotton - 4, Glass - 0

Insulation Material Specifications

- MATERIAL...** Molded closed cell vinyl (**ANTI-MICROBIAL**)
- DUROMETER...** 70 shore A
- COLOR...** Glossy White
- BURNING CHARACTERISTICS...**
- ASTM D 635: Less than 5 sec (ATB) 10mm (AEB)
- HEAT RESISTANCE...**
- ASTM C 177: BTU - in/hr - ft² - °F KValue = 1.02
- FUNGAL RESISTANCE...**
- ASTM G - 21: (Rating*) 0 fungal growth measured
- ASTM G - 22: (Rating*) 0 bacterial growth measured

See options and accessories section for details on product variations.

Specifications:

Wrought Brass Chrome Plated Wide Top Sink Strainer with 1-1/2 inch x 4 inch seamless brass tailpiece. Fits sink thickness up to 3/4 inch. Includes seamless ProWrap® tailpiece cover.



WARNING:

This product can expose you to chemicals including lead, which is known to the State of California to cause cancer, and birth defects or other reproductive harm. For more information go to www.P65Warnings.ca.gov.



McGuire Manufacturing Co., Inc.

60 Grandview Court
 Cheshire, Connecticut 06410
 (203) 699-1801 Fax (203) 699-1813
 customerservice@mcguiremfg.com mcguiremfg.com

Part No.

PW155HDWC

**Seamless PreWrapped Heavy
 Duty Offset Lavatory Strainer**

PRODUCT SPECIFICATION

Job Name:

Submittal Number:

Seamless PreWrapped Lavatory Strainer Insulation

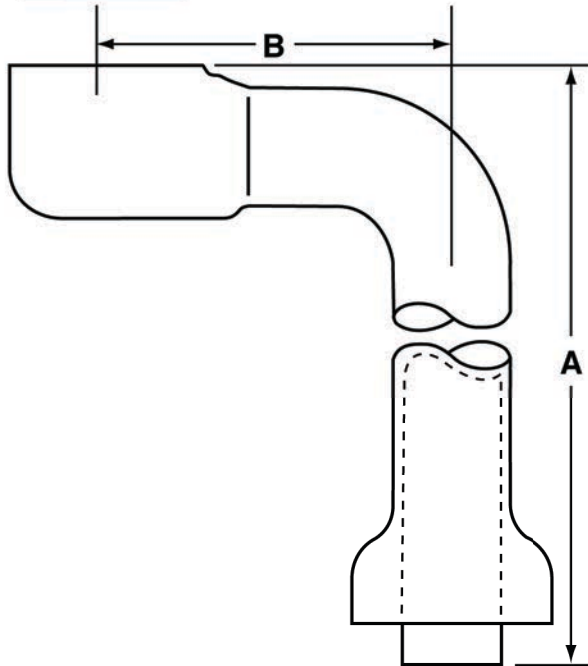
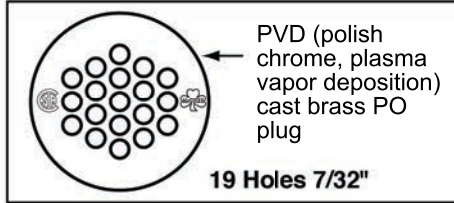

PROWRAP™

Insulation Material Specifications

- MATERIAL...** Molded closed cell vinyl (ANTI-MICROBIAL)
- DUROMETER...** 70 shore A
- COLOR...** Glossy White
- BURNING CHARACTERISTICS...**
 - ASTM D 635: Less than 5 sec (ATB) 10mm (AEB)
- HEAT RESISTANCE...**
 - ASTM C 177: BTU - in/hr - ft 2 - °F KValue = 1.02
- FUNGAL RESISTANCE...**
 - ASTM G - 21: (Rating*) 0 fungal growth measured
 - ASTM G - 22: (Rating*) 0 bacterial growth measured

*ASTM Rating - Observed Growth on Specimens

- 0 None
- 1 Traces of Growth (less than 10%)
- 2 Light Growth (10-30%)
- 3 Medium Growth (30-60%)
- 4 Heavy Growth (60%-complete coverage)

Environmental Controls:

Paper - 4, Cork - 1, Cotton - 4, Glass - 0

ROUGHING MEASUREMENTS

MODEL NO.	DESCRIPTION	A	B
PW155HDWC	1-1/4" - 17 G.A. - Lavatory Offset	8-3/4"	5-1/8"

A.D.A.



See options and accessories section for details on product variations.

Specifications:

Seamless prewrapped heavy duty offset lavatory strainer for ADA compliance. Furnished with PVD chrome plated brass lavatory grid strainer and 17 gauge prewrapped seamless offset brass tailpiece.



WARNING:

This product can expose you to chemicals including lead, which is known to the State of California to cause cancer, and birth defects or other reproductive harm. For more information go to www.P65Warnings.ca.gov.



McGuire Manufacturing Co., Inc.

60 Grandview Court
 Cheshire, Connecticut 06410
 (203) 699-1801 Fax (203) 699-1813
 customerservice@mcguiremfg.com mcguiremfg.com

Part No.
PW155WC, PW155LATWC,
PW155CRSWC,
PWProDrainWC

Seamless PreWrapped
Lavatory Strainer Insulation

PRODUCT SPECIFICATION

Job Name:

Submittal Number:

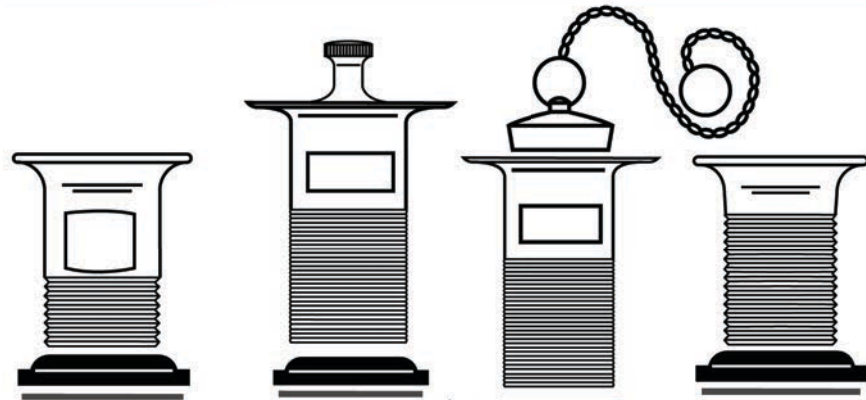

ProDrain™

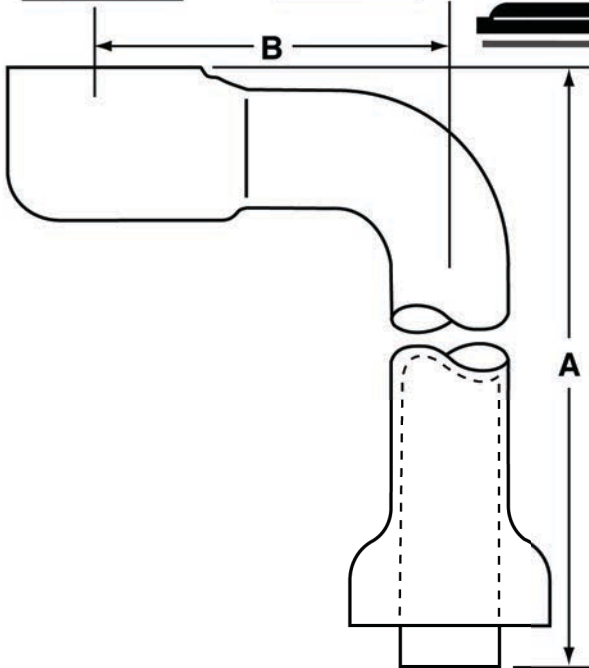
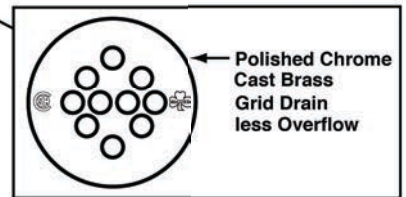

PROWRAP™

Insulation Material Specifications

- MATERIAL...** Molded closed cell vinyl (ANTI-MICROBIAL)
- DUROMETER...** 70 shore A
- COLOR...** Glossy White
- BURNING CHARACTERISTICS...**
 - ASTM D 635: Less than 5 sec (ATB) 10mm (AEB)
- HEAT RESISTANCE...**
 - ASTM C 177: BTU - in/hr - ft 2 - °F KValue = 1.02
- FUNGAL RESISTANCE...**
 - ASTM G - 21: (Rating*) 0 fungal growth measured
 - ASTM G - 22: (Rating*) 0 bacterial growth measured

- *ASTM Rating - Observed Growth on Specimens
- 0 None
 - 1 Traces of Growth (less than 10%)
 - 2 Light Growth (10-30%)
 - 3 Medium Growth (30-60%)
 - 4 Heavy Growth (60%-complete coverage)
- Environmental Controls:
 Paper - 4, Cork - 1, Cotton - 4, Glass - 0

ROUGHING MEASUREMENTS

MODEL NO.	DESCRIPTION	A	B
PW155WC	1-1/4" - 17 G.A. - Lavatory Offset	8-3/4"	5-1/8"
PW155LATWC	1-1/4" - 17 G.A. - Lift & Turn Offset	8-3/4"	5-1/8"
PW155CRSWC	1-1/4" - 17 G.A. - Chain & Stopper Offset	8-3/4"	5-1/8"
PWProDrainWC	1-1/4" - 17 G.A. - Lavatory Offset less overflow	8-3/4"	5-1/8"

A.D.A.



See options and accessories section for details on product variations.

Specifications:

Seamless PreWrapped Offset Lavatory Strainer for ADA compliance. Furnished with brass lavatory grid strainer and 17 gauge seamless brass tailpiece.

WARNING:

This product can expose you to chemicals including lead, which is known to the State of California to cause cancer, and birth defects or other reproductive harm. For more information go to www.P65Warnings.ca.gov.



McGuire Manufacturing Co., Inc.

60 Grandview Court
 P.O. Box 746 • Cheshire, CT 06410
 203-699-1801 • Fax: 203-699-1813
 www.mcguiremfg.com

PRODUCT SPECIFICATION

Part No.

PW1000WC, PW1151WC,
 PW1151AWC, PW1149WC, PW1152WC

**PreWrapped Offset Sink
 Strainer ADA Compliant**

Job Name:

Submittal Number:

PROWRAP™

*ASTM Rating - Observed Growth on Specimens

- 0 None
- 1 Traces of Growth (less than 10%)
- 2 Light Growth (10-30%)
- 3 Medium Growth (30-60%)
- 4 Heavy Growth (60%-complete coverage)

Environmental Controls:

Paper - 4, Cork - 1, Cotton - 4, Glass - 0

Insulation Material Specifications

MATERIAL... Molded closed cell vinyl (ANTI-MICROBIAL)

DUROMETER... 70 shore A

COLOR... Glossy White

BURNING CHARACTERISTICS...

ASTM D 635: Less than 5 sec (ATB) 10mm (AEB)

HEAT RESISTANCE...

ASTM C 177: BTU - in/hr - ft 2 - °F KValue = 1.02

FUNGAL RESISTANCE...

ASTM G - 21: (Rating*) 0 fungal growth measured

ASTM G - 22: (Rating*) 0 bacterial growth measured

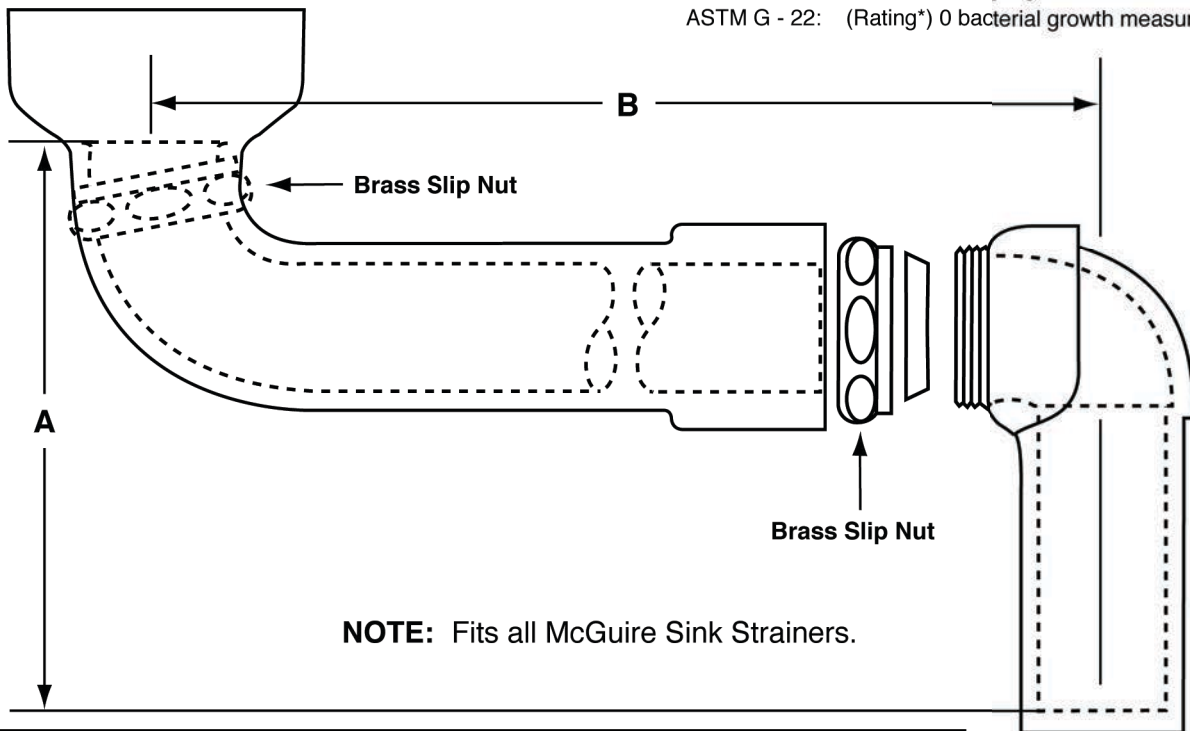

NOTE: Fits all McGuire Sink Strainers.

ROUGHING MEASUREMENTS

MODEL NO.	DESCRIPTION	A	B
PW1000WC	Offset Only	7"	12-3/4"
PW1151WC	Offset with 151 Brass Strainer	7"	12-3/4"
PW1151AWC	Offset with 151A Stainless Strainer	7"	12-3/4"
PW1149WC	Offset with 149 Brass Flat Grid Strainer	7"	12-3/4"
PW1152WC	Offset with 152 Brass Strainer	7"	12-3/4"

See options and accessories section for details on product variations.

A.D.A.



PW1151WC
 PW1151AWC

ASME A112.18.2/CSA B125.2

Specifications:

Seamless PreWrapped Adjustable Offset Sink Strainer for ADA compliance. Furnished with 17 gauge seamless brass waste arm, 17 gauge seamless brass tailpiece, cast brass slip nuts and heavy cast elbow. Sink strainer shall be in compliance with CSA or other recognized testing authority and bear both manufacturer and testing mark.



WARNING:

This product can expose you to chemicals including lead, which is known to the State of California to cause cancer, and birth defects or other reproductive harm. For more information go to www.P65Warnings.ca.gov.



McGuire Manufacturing Co., Inc.

60 Grandview Court
 Cheshire, Connecticut 06410
 (203) 699-1801 Fax (203) 699-1813
 customerservice@mcguiremfg.com mcguiremfg.com

PRODUCT SPECIFICATION

Part No.

PW2000, PW2000WC

**Seamless Retrofit
 P-Trap Insulation Kit**

Job Name:

Submittal Number:

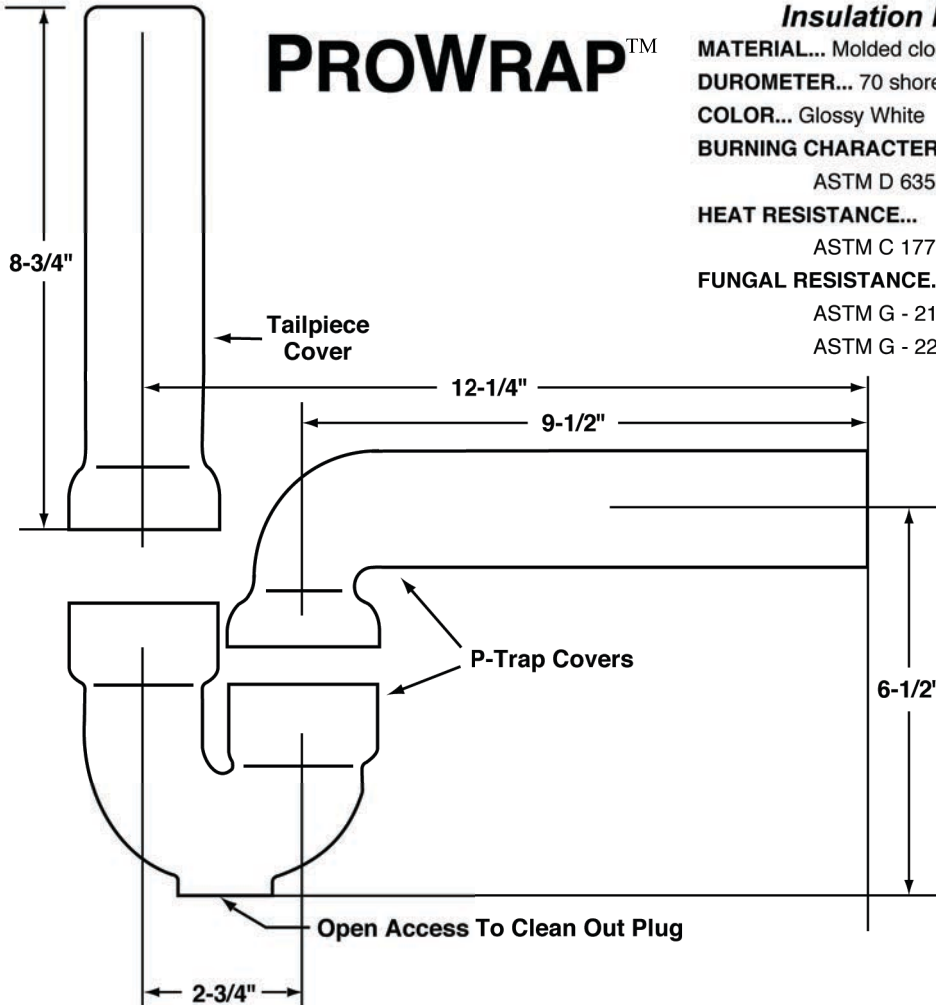

PROWRAP™

Insulation Material Specifications

- MATERIAL...** Molded closed cell vinyl (ANTI-MICROBIAL)
- DUROMETER...** 70 shore A
- COLOR...** Glossy White
- BURNING CHARACTERISTICS...**
 - ASTM D 635: Less than 5 sec (ATB) 10mm (AEB)
- HEAT RESISTANCE...**
 - ASTM C 177: BTU - in/hr - ft 2 - °F KValue = 1.02
- FUNGAL RESISTANCE...**
 - ASTM G - 21: (Rating*) 0 fungal growth measured
 - ASTM G - 22: (Rating*) 0 bacterial growth measured

Supply Covers (1 pair) Included With All P-Trap Kits

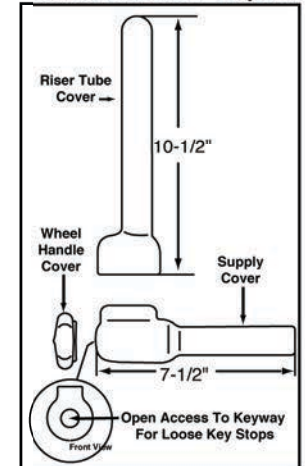

*ASTM Rating - Observed Growth on Specimens

- 0 None
- 1 Traces of Growth (less than 10%)
- 2 Light Growth (10-30%)
- 3 Medium Growth (30-60%)
- 4 Heavy Growth (60%-complete coverage)

Environmental Controls:

Paper - 4, Cork - 1, Cotton - 4, Glass - 0

MODEL NO.	DESCRIPTION
PW2000	For 1-1/4" & 1-1/2" P-Traps
PW2000WC	For 1-1/4" & 1-1/2" P-Traps with offset drain assembly

Note: PW2000 Retrofit Kit will accommodate 1-1/4" OR 1-1/2" brass P-traps.

A.D.A.



See options and accessories section for details on product variations.

Specifications:

Seamless Retrofit P-Trap Insulation Kit furnished with seamless riser tube covers, supply angle stop covers, seamless drain tailpiece cover and angle stop wheel handle covers.

WARNING:

This product can expose you to chemicals including lead, which is known to the State of California to cause cancer, and birth defects or other reproductive harm. For more information go to www.P65Warnings.ca.gov.



McGuire Manufacturing Co., Inc.

60 Grandview Court
 Cheshire, Connecticut 06410
 (203) 699-1801 Fax (203) 699-1813
 customerservice@mcguiremfg.com mcguiremfg.com

PRODUCT SPECIFICATION

Part No.

**PW2125, PW2150
 PW2150NCO**

**Seamless PreWrapped
 Cast P-Trap Insulation Kit**

Job Name:

Submittal Number:

PROWRAP™

Supply Covers (1 pair)
 Included With All P-Trap Kits

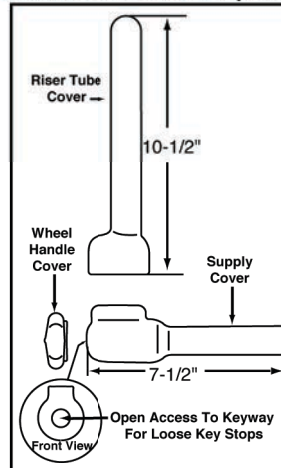

Insulation Material Specifications

MATERIAL... Molded closed cell vinyl (ANTI-MICROBIAL)

DUROMETER... 70 shore A

COLOR... Glossy White

BURNING CHARACTERISTICS...

ASTM D 635: Less than 5 sec (ATB) 10mm (AEB)

HEAT RESISTANCE...

ASTM C 177: BTU - in/hr - ft 2 - °F KValue = 1.02

FUNGAL RESISTANCE...

ASTM G - 21: (Rating*) 0 fungal growth measured

ASTM G - 22: (Rating*) 0 bacterial growth measured

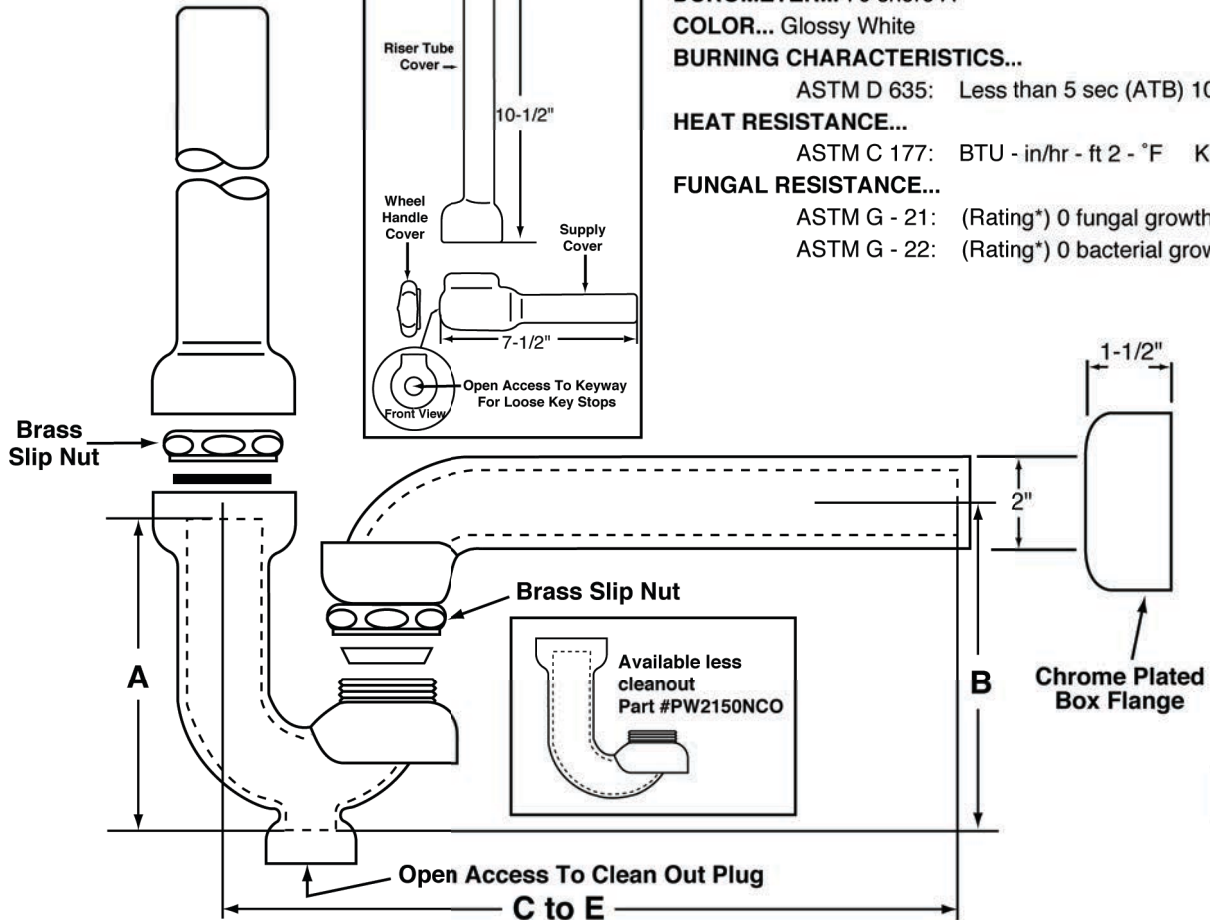

*ASTM Rating - Observed Growth on Specimens

- 0 None
- 1 Traces of Growth (less than 10%)
- 2 Light Growth (10-30%)
- 3 Medium Growth (30-60%)
- 4 Heavy Growth (60%-complete coverage)

Environmental Controls:

Paper - 4, Cork - 1, Cotton - 4, Glass - 0

ROUGHING MEASUREMENTS

NO.	P-TRAP DIMENSIONS	A	B
PW2125	1-1/4" - 17 G.A. - 11" C to E	5"	4-3/4"
PW2150	1-1/2" - 17 G.A. - 12" C to E	5-3/4"	5-1/2"
PW2150NCO	1-1/2" - 17 G.A. - 12" C to E	5"	5"

Note: PW2125 includes McGuire 8872 P-Trap.

Note: PW2150 includes McGuire (8902 - 8912) P-Trap and ships with additional 1-1/4" x 1-1/2" brass reducing nut and washer.

See options and accessories section for details on product variations.

Specifications:

Seamless PreWrapped Adjustable Cast Brass P-Trap Kit furnished with McGuire cast brass adjustable P-Trap with or without cleanout, seamless supply riser tube covers, supply angle stop covers, seamless drain tailpiece cover and angle stop wheel handle covers, and chrome plated box flange.



WARNING:

This product can expose you to chemicals including lead, which is known to the State of California to cause cancer, and birth defects or other reproductive harm. For more information go to www.P65Warnings.ca.gov.



McGuire Manufacturing Co., Inc.

60 Grandview Court
 P.O. Box 746 • Cheshire, CT 06410
 203-699-1801 • Fax: 203-699-1813
 www.mcguiremfg.com

PRODUCT SPECIFICATION

Part No.

**PW2125HDWC,
 PW2150HDWC**

Seamless PreWrapped Cast
 P-Trap Insulation Kit with
 PreWrapped HD Offset PO Plug

Job Name:

Submittal Number:

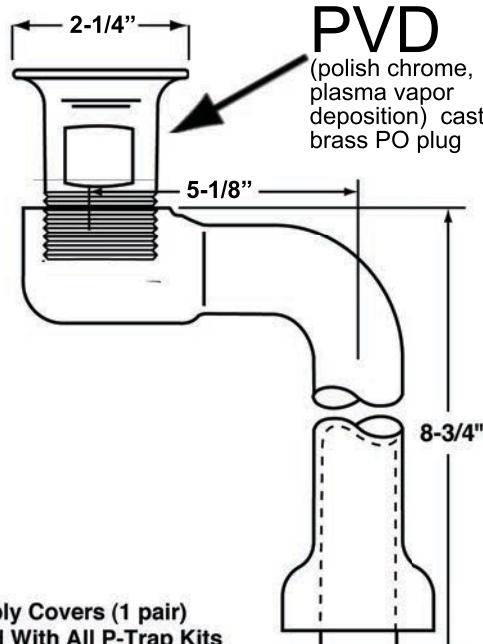

Insulation Material Specifications

- MATERIAL...** Molded closed cell vinyl (ANTI-MICROBIAL)
- DUROMETER...** 70 shore A
- COLOR...** Glossy White
- BURNING CHARACTERISTICS...**
 - ASTM D 635: Less than 5 sec (ATB) 10mm (AEB)
- HEAT RESISTANCE...**
 - ASTM C 177: BTU - in/hr - ft 2 - °F KValue = 1.02
- FUNGAL RESISTANCE...**
 - ASTM G - 21: (Rating*) 0 fungal growth measured
 - ASTM G - 22: (Rating*) 0 bacterial growth measured

*ASTM Rating - Observed Growth on Specimens

0	None
1	Traces of Growth (less than 10%)
2	Light Growth (10-30%)
3	Medium Growth (30-60%)
4	Heavy Growth (60%-complete coverage)

Environmental Controls:
 Paper - 4, Cork - 1, Cotton - 4, Glass - 0

Supply Covers (1 pair) Included With All P-Trap Kits

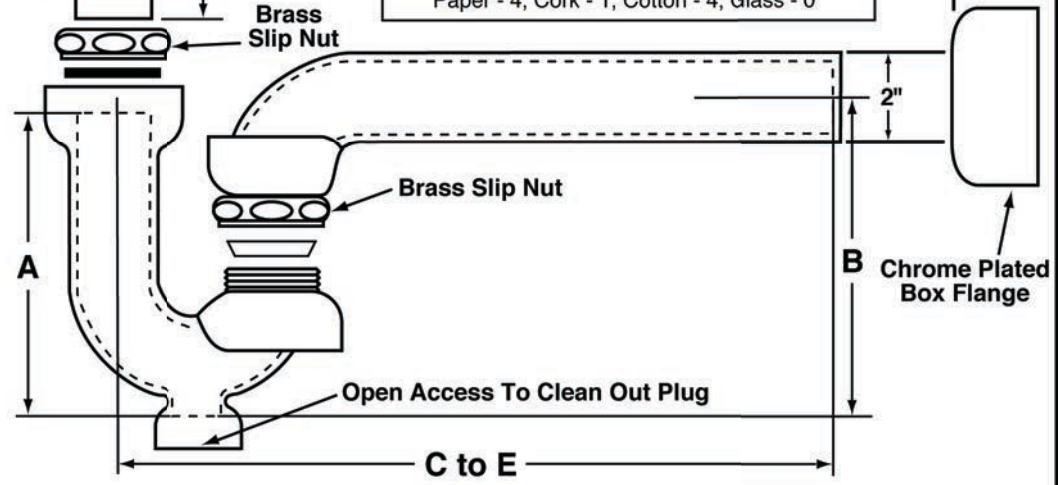
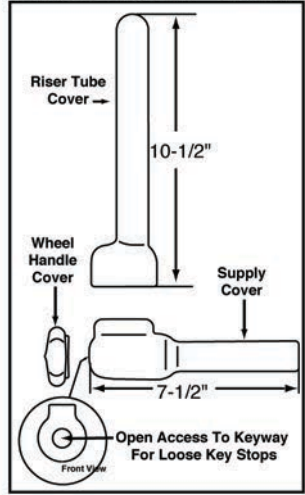

ROUGHING MEASUREMENTS			
NO.	P-TRAP DIMENSIONS	A	B
PW2125HDWC	1-1/4" - 17 G.A. - 11" C to E	5"	4-1/2"
PW2150HDWC	1-1/2" - 17 G.A. - 12" C to E	5"	4-1/2"

See options and accessories section for details on product variations.

PROWRAP®



MADE IN USA
 U.S. PATENT
 5,341,830 5,586,568
 5,904,175 5,911,237
 5,795,623 5,678,598

Specifications:

Seamless prewrapped adjustable cast brass P-Trap kit with prewrapped offset HD (heavy duty) PVD (polish chrome, plasma vapor deposition) cast brass PO plug with overflow. Furnished with McGuire cast brass P-Trap with cleanout, offset grid assembly, seamless riser tube covers, supply angle stop wheel handle covers, and chrome plated box flange.

! WARNING:

This product can expose you to chemicals including lead, which is known to the State of California to cause cancer, and birth defects or other reproductive harm. For more information go to www.P65Warnings.ca.gov.



McGuire Manufacturing Co., Inc.

60 Grandview Court
 Cheshire, Connecticut 06410
 (203) 699-1801 Fax (203) 699-1813
 customerservice@mcguiremfg.com mcguiremfg.com

Part No.

**PW2125WCPRO,
 PW2150WCPRO**

**Seamless PreWrapped Cast P-Trap
 Insulation Kit, with PreWrapped
 Offset No Overflow Strainer**

PRODUCT SPECIFICATION

Job Name:

Submittal Number:



PRODRAIN™

Insulation Material Specifications

MATERIAL... Molded closed cell vinyl (ANTI-MICROBIAL)

DUROMETER... 70 shore A

COLOR... Glossy White

BURNING CHARACTERISTICS...

ASTM D 635: Less than 5 sec (ATB) 10mm (AEB)

HEAT RESISTANCE...

ASTM C 177: BTU - in/hr - ft 2 - °F KValue = 1.02

FUNGAL RESISTANCE...

ASTM G - 21: (Rating*) 0 fungal growth measured

ASTM G - 22: (Rating*) 0 bacterial growth measured

PROWRAP™

**Supply Covers (1 pair)
 Included With All P-Trap Kits**

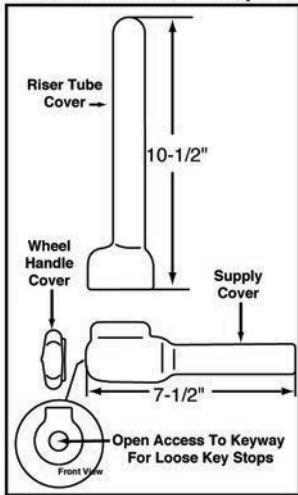

*ASTM Rating - Observed Growth on Specimens
 0 None
 1 Traces of Growth (less than 10%)
 2 Light Growth (10-30%)
 3 Medium Growth (30-60%)
 4 Heavy Growth (60%-complete coverage)
 Environmental Controls:
 Paper - 4, Cork - 1, Cotton - 4, Glass - 0

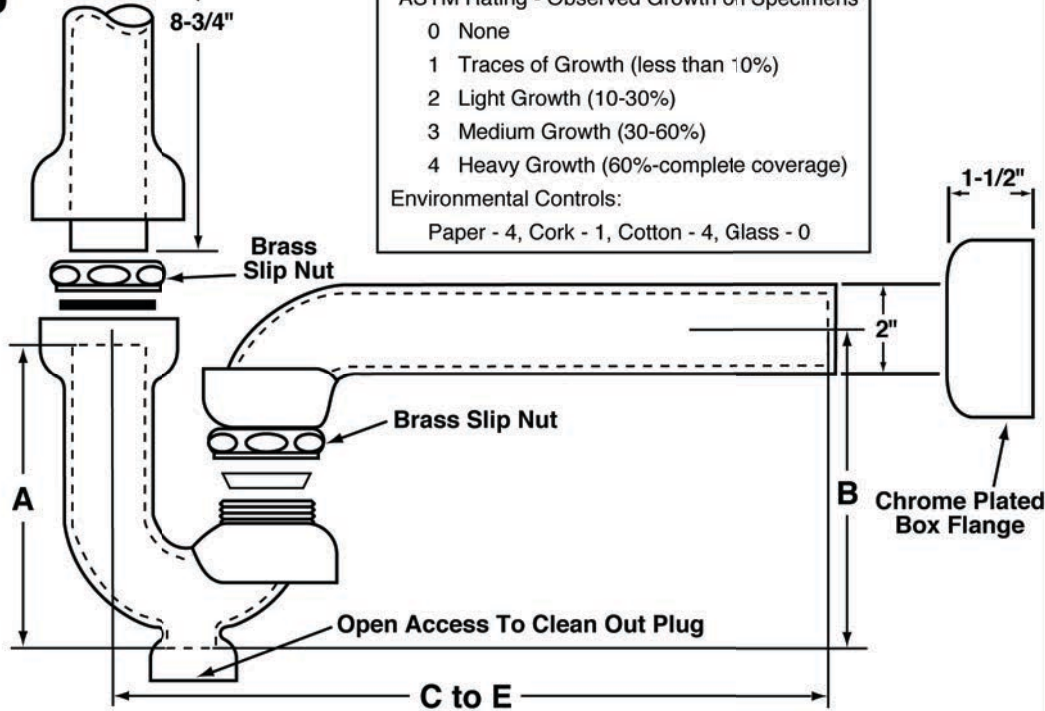

ROUGHING MEASUREMENTS				
NO.	P-TRAP DIMENSIONS	A	B	
PW2125WCPRO	1-1/4" - 17 G.A. - 11" C to E	5"	4-1/2"	
PW2150WCPRO	1-1/2" - 17 G.A. - 12" C to E	5"	4-1/2"	

Note: PW2125WCPRO includes McGuire ProDrainWC Offset Strainer and 8872 P-Trap.
Note: PW2150WCPRO includes McGuire ProDrainWC Offset Strainer and (8902-8912) P-Trap.
Note: PW2150WCPRO ships with additional 1-1/4" x 1-1/2" brass reducing nut and washer.



See options and accessories section for details on product variations.

Specifications:

Seamless PreWrapped Adjustable Cast Brass P-Trap Kit with PreWrapped ProDrain® offset grid drain. Furnished with McGuire cast brass adjustable P-Trap with cleanout, ProDrain® offset grid drain assembly, seamless riser tube covers, supply angle stop covers, angle stop wheel handle covers, and chrome lated box flange.

WARNING:

This product can expose you to chemicals including lead, which is known to the State of California to cause cancer, and birth defects or other reproductive harm. For more information go to www.P65Warnings.ca.gov.



McGuire Manufacturing Co., Inc.

60 Grandview Court
 Cheshire, Connecticut 06410
 (203) 699-1801 Fax (203) 699-1813
 customerservice@mcguiremfg.com mcguiremfg.com

Part No.

PW2150GJ

**Seamless PreWrapped
 Cast P-Trap Insulation Kit**

PRODUCT SPECIFICATION

Job Name:

Submittal Number:

PROWRAP™

Supply Covers (1 pair)
 Included With All P-Trap Kits

Note: PW2150GJ formerly PW2150LA

Insulation Material Specifications

- MATERIAL...** Molded closed cell vinyl (ANTI-MICROBIAL)
- DUROMETER...** 70 shore A
- COLOR...** Glossy White
- BURNING CHARACTERISTICS...**
 - ASTM D 635: Less than 5 sec (ATB) 10mm (AEB)
- HEAT RESISTANCE...**
 - ASTM C 177: BTU - in/hr - ft 2 - °F KValue = 1.02
- FUNGAL RESISTANCE...**
 - ASTM G - 21: (Rating*) 0 fungal growth measured
 - ASTM G - 22: (Rating*) 0 bacterial growth measured

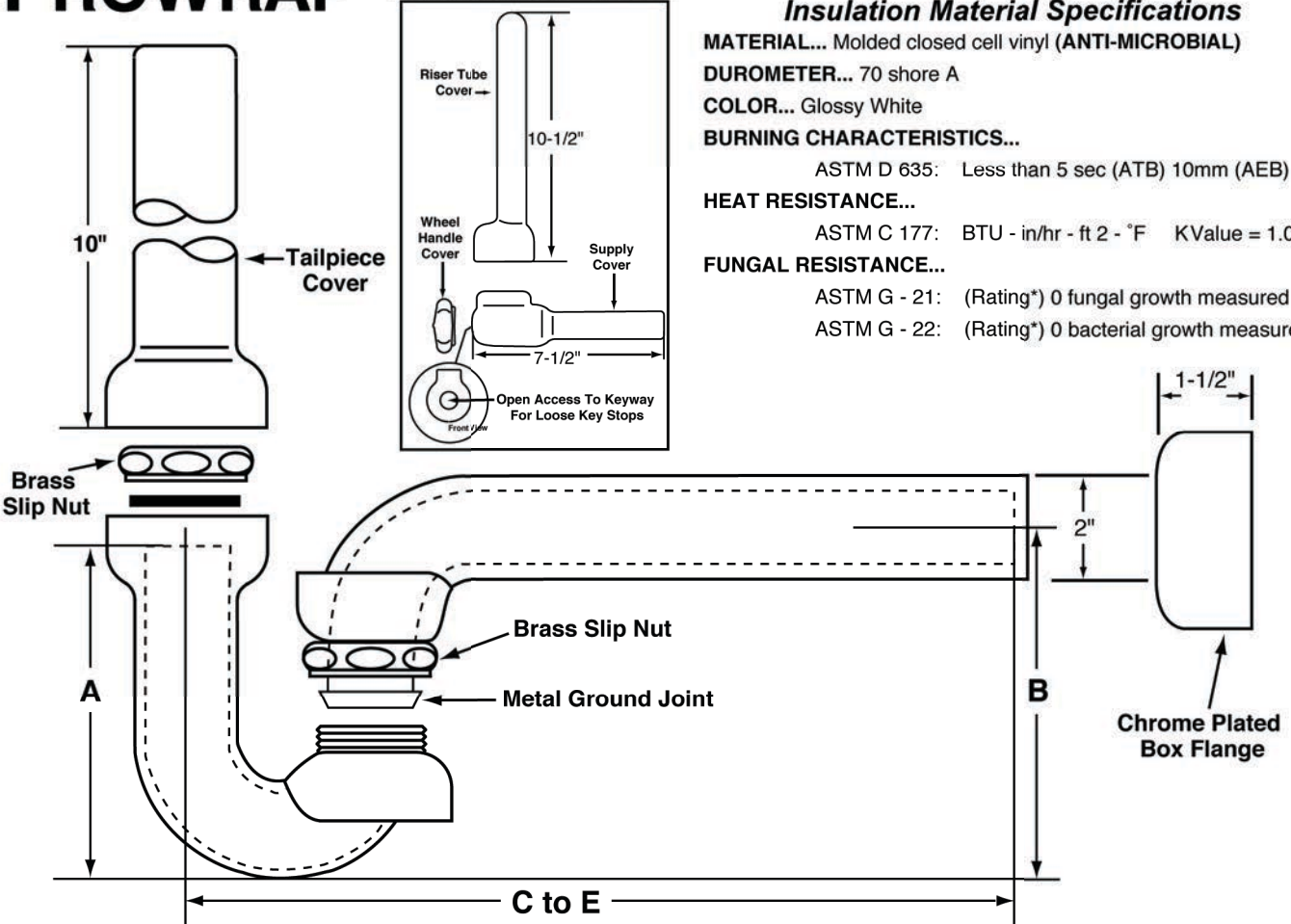

*ASTM Rating - Observed Growth on Specimens

- 0 None
- 1 Traces of Growth (less than 10%)
- 2 Light Growth (10-30%)
- 3 Medium Growth (30-60%)
- 4 Heavy Growth (60%-complete coverage)

Environmental Controls:
 Paper - 4, Cork - 1, Cotton - 4, Glass - 0

ROUGHING MEASUREMENTS			
NO.	P-TRAP DIMENSIONS	A	B
PW2150GJ	1-1/2" - 17 G.A. - 12" C to E	5"	4-3/4"

Note: PW2150GJ includes McGuire 8902CNC - 8912CNC P-Trap.
Note: PW2150GJ ships with additional 1-1/4" x 1-1/2" brass reducing nut and washer.



See options and accessories section for details on product variations.

Specifications:

Seamless PreWrapped Adjustable Cast Brass P-Trap Kit furnished with McGuire cast brass adjustable P-Trap less cleanout, 17 gauge metal ground joint wall bend, seamless supply riser tube covers, supply angle stop covers, angle stop wheel handle covers and chrome plated box flange.

WARNING:

This product can expose you to chemicals including lead, which is known to the State of California to cause cancer, and birth defects or other reproductive harm. For more information go to www.P65Warnings.ca.gov.



McGuire Manufacturing Co., Inc.

60 Grandview Court
 Cheshire, Connecticut 06410
 (203) 699-1801 Fax (203) 699-1813
 customerservice@mcguiremfg.com mcguiremfg.com

PRODUCT SPECIFICATION

Part No.

PW2150GJWC

**Seamless PreWrapped
 Cast P-Trap Insulation Kit**

Job Name:

Submittal Number:

Note: PW2150GJWC formerly PW2150LAWC

PROWRAP™

Insulation Material Specifications

MATERIAL... Molded closed cell vinyl (ANTI-MICROBIAL)

DUROMETER... 70 shore A

COLOR... Glossy White

BURNING CHARACTERISTICS...

ASTM D 635: Less than 5 sec (ATB) 10mm (AEB)

HEAT RESISTANCE...

ASTM C 177: BTU - in/hr - ft 2 - °F KValue = 1.02

FUNGAL RESISTANCE...

ASTM G - 21: (Rating*) 0 fungal growth measured

ASTM G - 22: (Rating*) 0 bacterial growth measured

*ASTM Rating - Observed Growth on Specimens

- 0 None
- 1 Traces of Growth (less than 10%)
- 2 Light Growth (10-30%)
- 3 Medium Growth (30-60%)
- 4 Heavy Growth (60%-complete coverage)

Environmental Controls:

Paper - 4, Cork - 1, Cotton - 4, Glass - 0

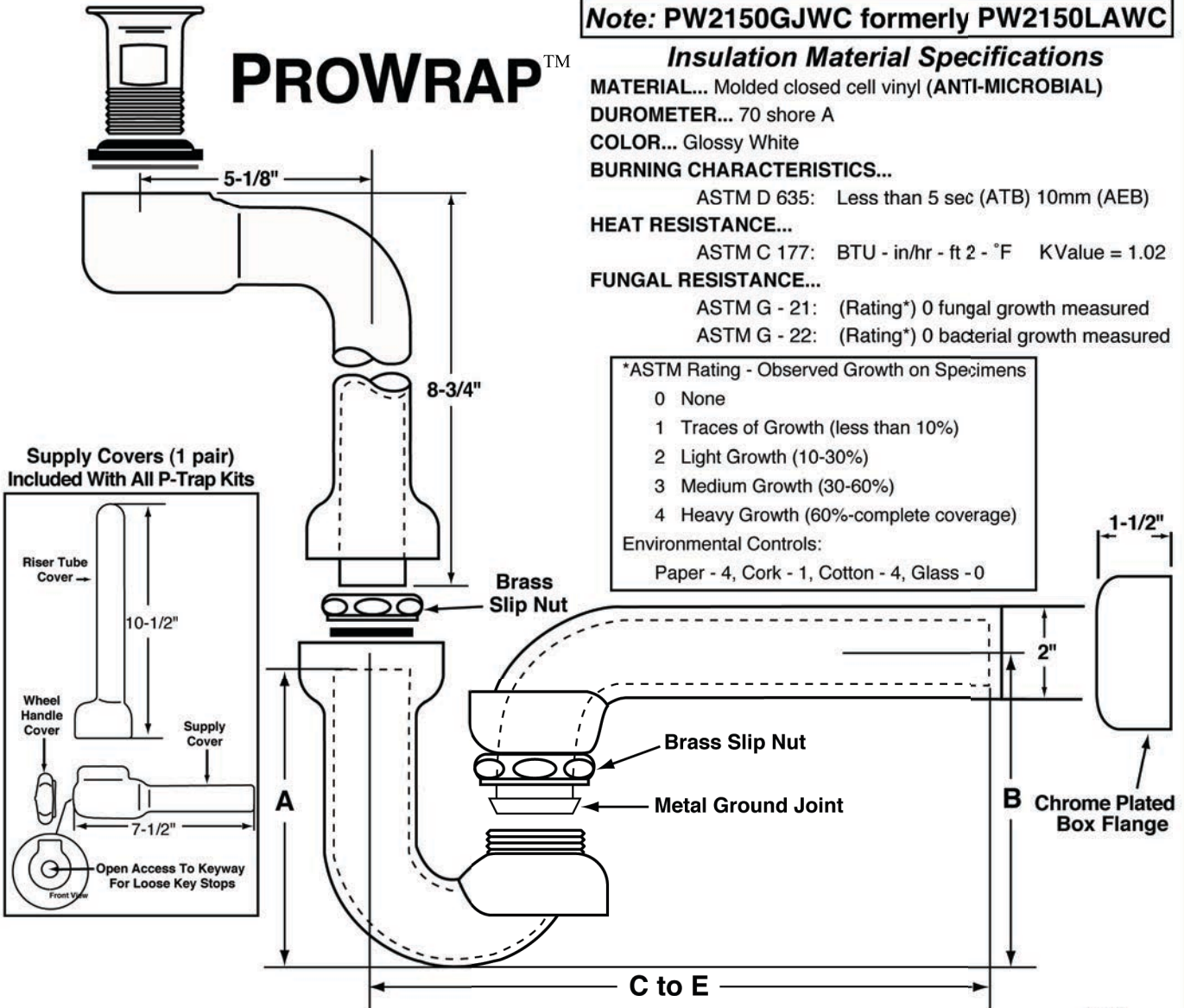

Supply Covers (1 pair)
 Included With All P-Trap Kits

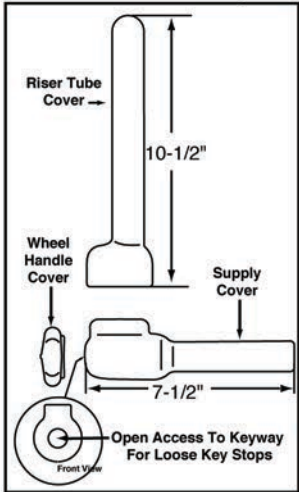

ROUGHING MEASUREMENTS			
NO.	P-TRAP DIMENSIONS	A	B
PW2150GJWC	1-1/2" - 17 G.A. - 12" C to E	5"	4-1/2"

Note: PW2150GJWC includes McGuire 155WC Offset Strainer and 8902CNCGJ - 8912CNCGJ P-Trap.

Note: PW2150GJWC ships with additional 1-1/4" x 1-1/2" brass reducing nut and washer.

A.D.A.



See options and accessories section for details on product variations.

Specifications:

Seamless PreWrapped Adjustable Cast Brass P-Trap Kit with PreWrapped offset grid drain. Furnished with McGuire cast brass adjustable P-Trap less cleanout, 17 gauge metal ground joint wall bend, offset grid drain assembly, seamless supply riser tube covers, supply angle stop covers, angle stop wheel handle covers and chrome plated box flange.



WARNING:
 This product can expose you to chemicals including lead, which is known to the State of California to cause cancer, and birth defects or other reproductive harm. For more information go to www.P65Warnings.ca.gov.



McGuire Manufacturing Co., Inc.

60 Grandview Court
 Cheshire, Connecticut 06410
 (203) 699-1801 Fax (203) 699-1813
 customerservice@mcguiremfg.com mcguiremfg.com

Part No.

PW8089, PW8090

**Seamless PreWrapped
 Cast P-Trap Insulation Kit**

PRODUCT SPECIFICATION

Job Name:

Submittal Number:

PROWRAP

Insulation Material Specifications

- MATERIAL...** Molded closed cell vinyl (**ANTI-MICROBIAL**)
DUROMETER... 70 shore A
COLOR... Glossy White
BURNING CHARACTERISTICS...
 ASTM D 635: Less than 5 sec (ATB) 10mm (AEB)
HEAT RESISTANCE...
 ASTM C 177: BTU - in/hr - ft 2 - °F KValue = 1.02
FUNGAL RESISTANCE...
 ASTM G - 21: (Rating*) 0 fungal growth measured
 ASTM G - 22: (Rating*) 0 bacterial growth measured

*ASTM Rating - Observed Growth on Specimens

- 0 None
- 1 Traces of Growth (less than 10%)
- 2 Light Growth (10-30%)
- 3 Medium Growth (30-60%)
- 4 Heavy Growth (60%-complete coverage)

Environmental Controls:

- Paper - 4, Cork - 1, Cotton - 4, Glass - 0

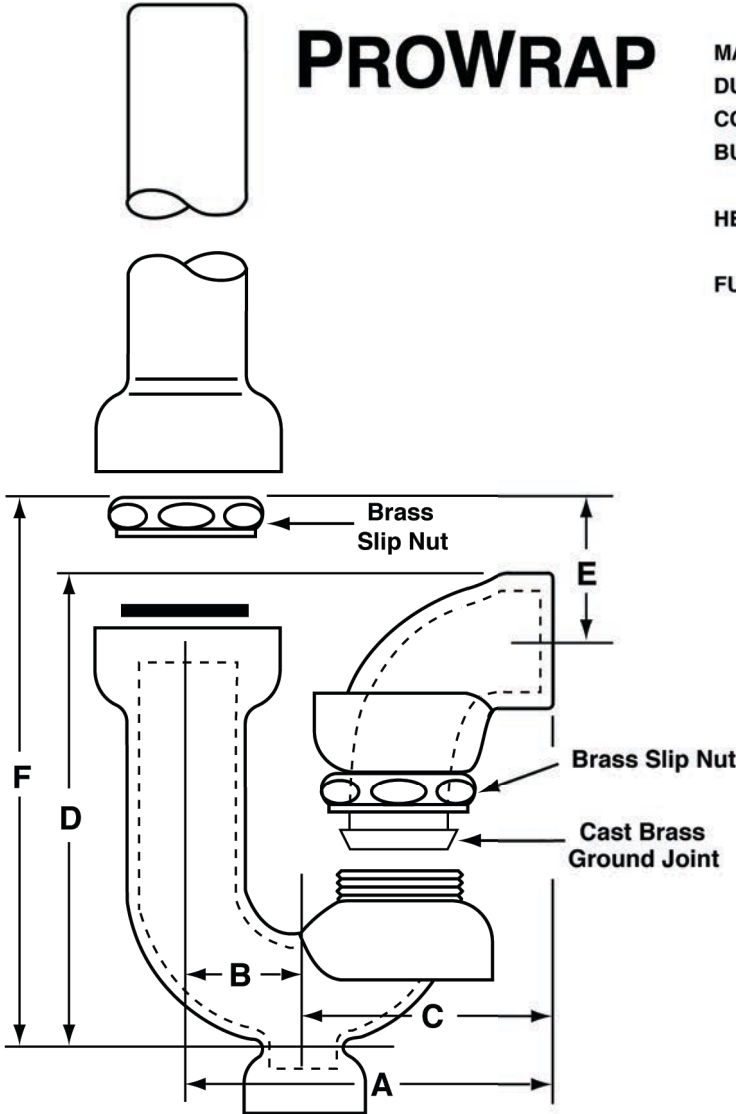

Supply Covers (1 pair) Included With All P-Trap Kits

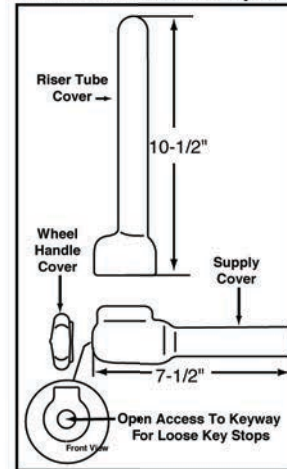

ROUGHING MEASUREMENTS

NO.	INLET	OUTLET	A	B	C	D	E	F
PW8089	1-1/2"	S.P.S. 1-1/2"	4-1/4"	1-3/8"	2-7/8"	5-3/4"	11/16"	4-5/8"
PW8090	1-1/4"	S.P.S. 1-1/2"	4-1/4"	1-3/8"	2-7/8"	5-3/4"	11/16"	4-5/8"

See options and accessories section for details on product variations.

8089 and 8090 is ASME
 A112.18.2/CSA B125.2



Specifications:

Seamless PreWrapped All Cast Brass Ground Joint Swivel P-Trap Kit furnished with McGuire cast brass ground joint swivel P-Trap with cleanout, seamless supply riser tube covers, supply angle stop covers and angle stop wheel handle covers.



WARNING:

This product can expose you to chemicals including lead, which is known to the State of California to cause cancer, and birth defects or other reproductive harm. For more information go to www.P65Warnings.ca.gov.



McGuire Manufacturing Co., Inc.

60 Grandview Court
 Cheshire, Connecticut 06410
 (203) 699-1801 Fax (203) 699-1813
 customerservice@mcguiremfg.com mcguiremfg.com

PRODUCT SPECIFICATION

Part No.

**PW8089NCO,
 PW8090NCO**

Seamless PreWrapped Cast P-Trap Insulation Kit

Job Name:

Submittal Number:

PROWRAP™

Insulation Material Specifications

MATERIAL... Molded closed cell vinyl (ANTI-MICROBIAL)
DUROMETER... 70 shore A
COLOR... Glossy White
BURNING CHARACTERISTICS...
 ASTM D 635: Less than 5 sec (ATB) 10mm (AEB)
HEAT RESISTANCE...
 ASTM C 177: BTU - in/hr - ft 2 - °F KValue = 1.02
FUNGAL RESISTANCE...
 ASTM G - 21: (Rating*) 0 fungal growth measured
 ASTM G - 22: (Rating*) 0 bacterial growth measured

*ASTM Rating - Observed Growth on Specimens

- 0 None
- 1 Traces of Growth (less than 10%)
- 2 Light Growth (10-30%)
- 3 Medium Growth (30-60%)
- 4 Heavy Growth (60%-complete coverage)

Environmental Controls:

Paper - 4, Cork - 1, Cotton - 4, Glass - 0

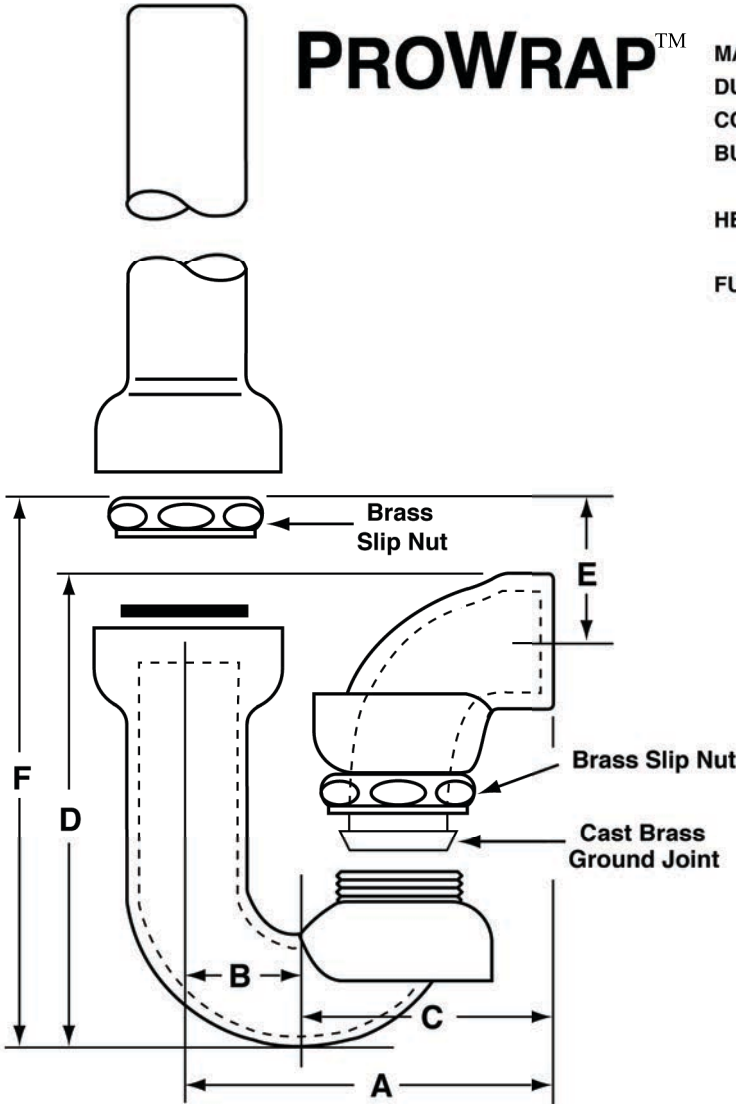

Supply Covers (1 pair) Included With All P-Trap Kits

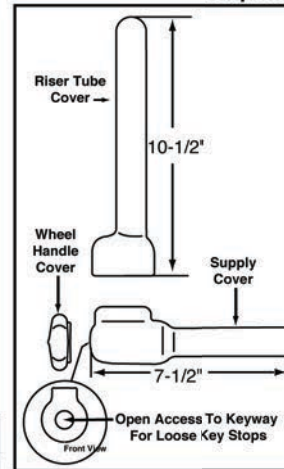

ROUGHING MEASUREMENTS

NO.	INLET	OUTLET	A	B	C	D	E	F
PW8089NCO	1-1/2"	S.P.S. 1-1/2"	4-1/4"	1-3/8"	2-7/8"	5-3/4"	11/16"	4-5/8"
PW8090NCO	1-1/4"	S.P.S. 1-1/2"	4-1/4"	1-3/8"	2-7/8"	5-3/4"	11/16"	4-5/8"

See options and accessories section for details on product variations.

Specifications:

Seamless PreWrapped All Cast Brass Ground Joint Swivel P-Trap Kit furnished with McGuire cast brass ground joint swivel P-Trap less cleanout, seamless supply riser tube covers, supply angle stop covers and angle stop wheel handle covers.



WARNING:

This product can expose you to chemicals including lead, which is known to the State of California to cause cancer, and birth defects or other reproductive harm. For more information go to www.P65Warnings.ca.gov.

A.D.A.





McGuire Manufacturing Co., Inc.

60 Grandview Court
 Cheshire, Connecticut 06410
 (203) 699-1801 Fax (203) 699-1813
 customerservice@mcguiremfg.com mcguiremfg.com

Part No.

PW215015

**Seamless PreWrapped
 Cast P-Trap Insulation Kit**

PRODUCT SPECIFICATION

Job Name:

Submittal Number:

PROWRAP™

Supply Covers (1 pair)
 Included With All P-Trap Kits

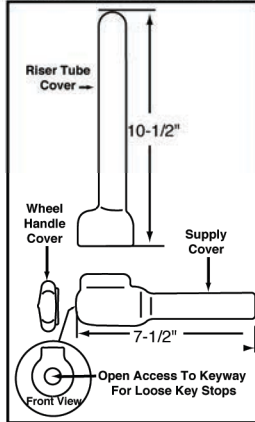

Insulation Material Specifications

- MATERIAL...** Molded closed cell vinyl (ANTI-MICROBIAL)
- DUROMETER...** 70 shore A
- COLOR...** Glossy White
- BURNING CHARACTERISTICS...**
 - ASTM D 635: Less than 5 sec (ATB) 10mm (AEB)
- HEAT RESISTANCE...**
 - ASTM C 177: BTU - in/hr - ft 2 - °F KValue = 1.02
- FUNGAL RESISTANCE...**
 - ASTM G - 21: (Rating*) 0 fungal growth measured
 - ASTM G - 22: (Rating*) 0 bacterial growth measured

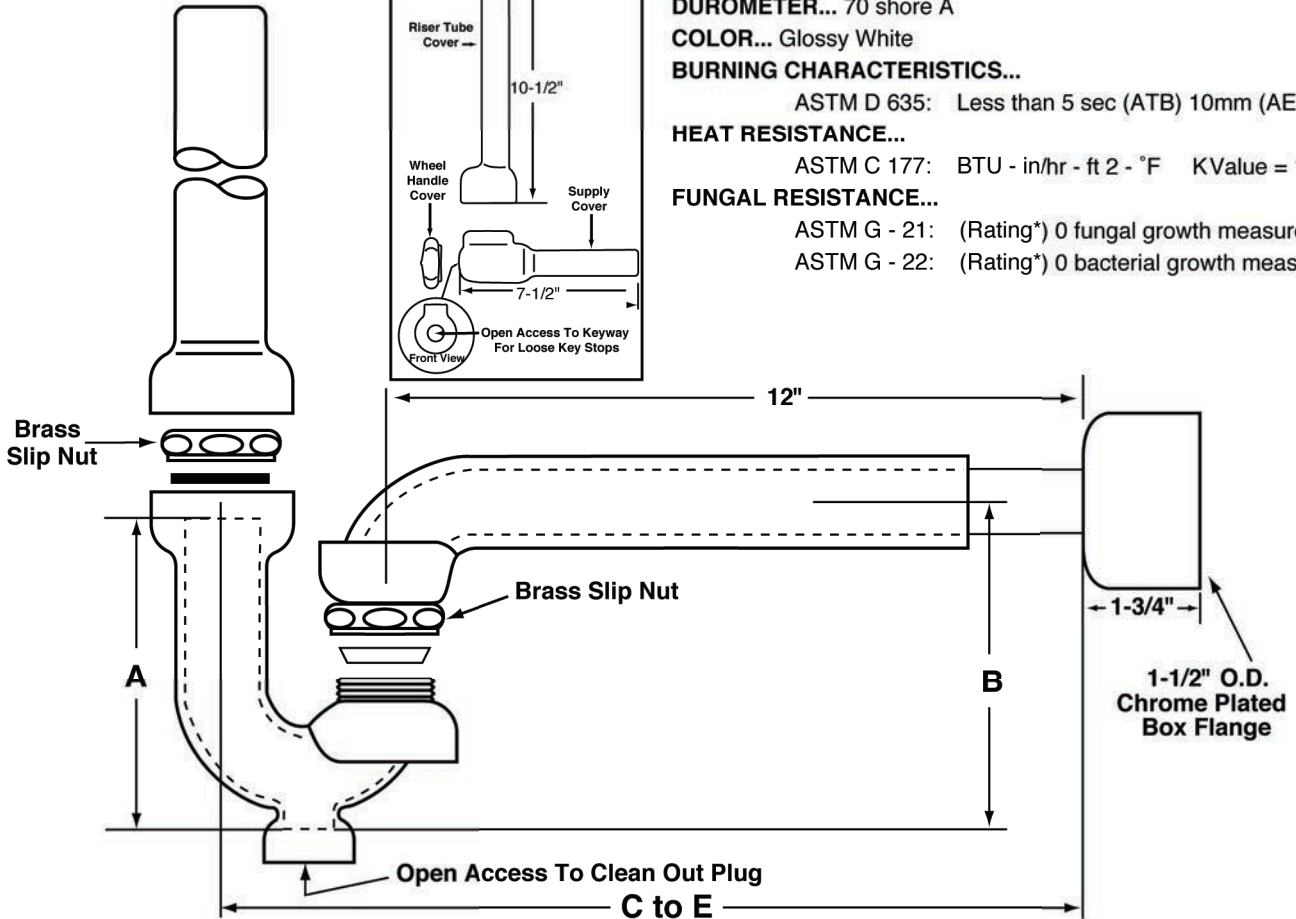

*ASTM Rating - Observed Growth on Specimens

- 0 None
- 1 Traces of Growth (less than 10%)
- 2 Light Growth (10-30%)
- 3 Medium Growth (30-60%)
- 4 Heavy Growth (60%-complete coverage)

Environmental Controls:

Paper - 4, Cork - 1, Cotton - 4, Glass - 0

ROUGHING MEASUREMENTS

NO.	P-TRAP DIMENSIONS	A	B
PW215015	1-1/2" - 17 G.A. - 15" C to E	5"	4-1/2"

Note: PW215015 includes McGuire (8902C15-8912C15) P-Trap and ships with additional 1-1/4" x 1-1/2" brass reducing nut and washer.

A.D.A.



See options and accessories section for details on product variations.

Specifications:

Seamless PreWrapped Adjustable Cast Brass P-Trap Kit furnished with McGuire cast brass adjustable P-Trap with or without cleanout, seamless supply riser tube covers, supply angle stop covers, seamless drain tailpiece cover and angle stop wheel handle covers, and chrome plated box flange.

WARNING:

This product can expose you to chemicals including lead, which is known to the State of California to cause cancer, and birth defects or other reproductive harm. For more information go to www.P65Warnings.ca.gov.



McGuire Manufacturing Co., Inc.

60 Grandview Court
 Cheshire, Connecticut 06410
 (203) 699-1801 Fax (203) 699-1813
 customerservice@mcguiremfg.com mcguiremfg.com

PRODUCT SPECIFICATION

Part No.

PWV8089, PWV8090

**Seamless PreWrapped
 Cast P-Trap Insulation Kit
 Vandal Resistant**

Job Name:

Submittal Number:

PROWRAPTM Vandal Trap[®]

Insulation Material Specifications

MATERIAL... Molded closed cell vinyl (ANTI-MICROBIAL)

DUROMETER... 70 shore A

COLOR... Glossy White

BURNING CHARACTERISTICS...

ASTM D 635: Less than 5 sec (ATB) 10mm (AEB)

HEAT RESISTANCE...

ASTM C 177: BTU - in/hr - ft 2 - °F KValue = 1.02

FUNGAL RESISTANCE...

ASTM G - 21: (Rating*) 0 fungal growth measured

ASTM G - 22: (Rating*) 0 bacterial growth measured

*ASTM Rating - Observed Growth on Specimens

- 0 None
- 1 Traces of Growth (less than 10%)
- 2 Light Growth (10-30%)
- 3 Medium Growth (30-60%)
- 4 Heavy Growth (60%-complete coverage)

Environmental Controls:

Paper - 4, Cork - 1, Cotton - 4, Glass - 0

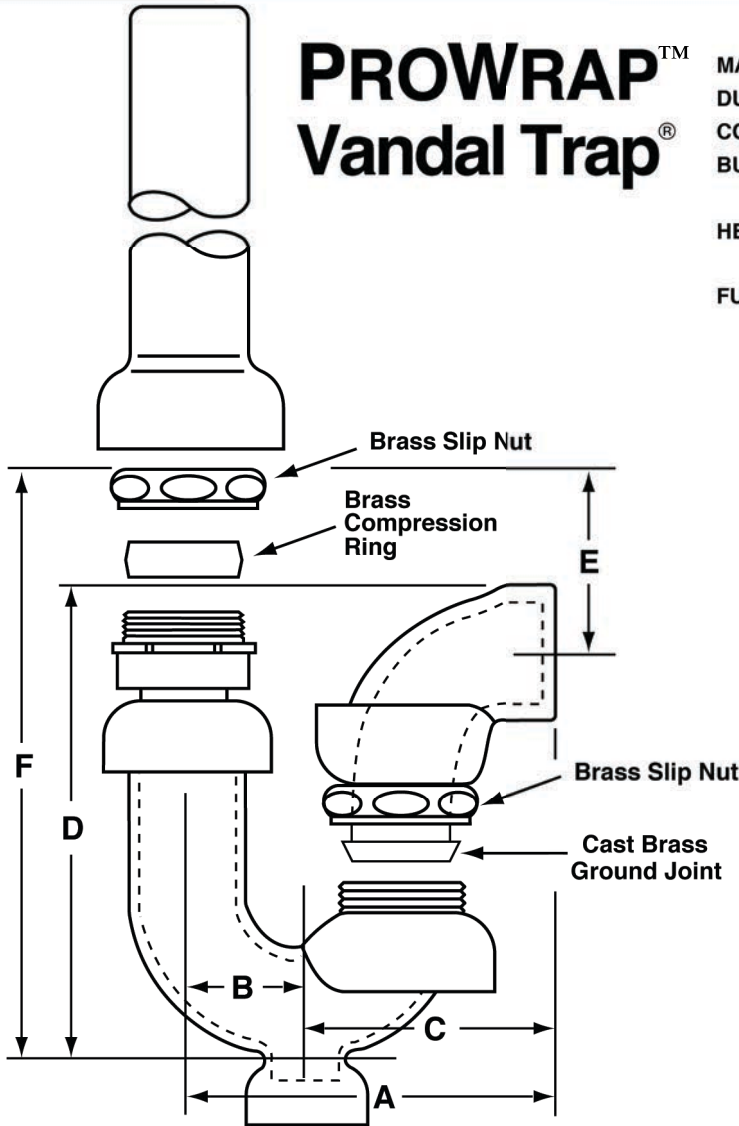

Supply Covers (1 pair) Included With All P-Trap Kits

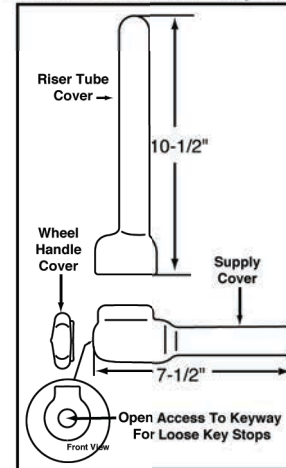

ROUGHING MEASUREMENTS

NO.	INLET	OUTLET	A	B	C	D	E	F
PWV8089	1-1/2"	S.P.S. 1-1/2"	4-1/4"	1-3/8"	2-7/8"	5-3/4"	11/16"	4-5/8"
PWV8090	1-1/4"	S.P.S. 1-1/2"	4-1/4"	1-3/8"	2-7/8"	5-3/4"	11/16"	4-5/8"

See options and accessories section for details on product variations.



V8089 and V8090 is
 US ASME A112.2/CSA



Specifications:

Seamless PreWrapped All Cast Brass Ground Joint Swivel P-Trap Kit furnished with McGuire's Vandal Trap @, Vandal Resistant P-Trap with cleanout and cast brass ground joint elbow. Includes seamless supply riser tube covers, supply angle stop covers and angle stop wheel handle covers.



WARNING:

This product can expose you to chemicals including lead, which is known to the State of California to cause cancer, and birth defects or other reproductive harm. For more information go to www.P65Warnings.ca.gov.



McGuire Manufacturing Co., Inc.

60 Grandview Court
 Cheshire, Connecticut 06410
 (203) 699-1801 Fax (203) 699-1813
 customerservice@mcguiremfg.com mcguiremfg.com

PRODUCT SPECIFICATION

Part No.

PWV8902, PWV8912

**Seamless PreWrapped
 Cast P-Trap Insulation Kit
 Vandal Resistant**

Job Name:

Submittal Number:

**Supply Covers (1 pair)
 Included With All P-Trap Kits**

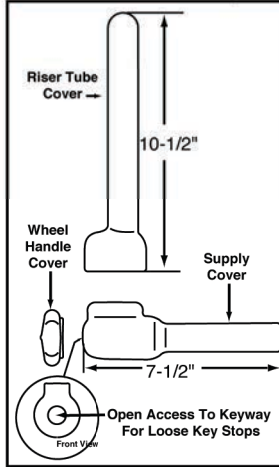

Insulation Material Specifications

MATERIAL... Molded closed cell vinyl (ANTI-MICROBIAL)
DUROMETER... 70 shore A
COLOR... Glossy White
BURNING CHARACTERISTICS...
 ASTM D 635: Less than 5 sec (ATB) 10mm (AEB)
HEAT RESISTANCE...
 ASTM C 177: BTU - in/hr - ft 2 - °F KValue = 1.02
FUNGAL RESISTANCE...
 ASTM G - 21: (Rating*) 0 fungal growth measured
 ASTM G - 22: (Rating*) 0 bacterial growth measured

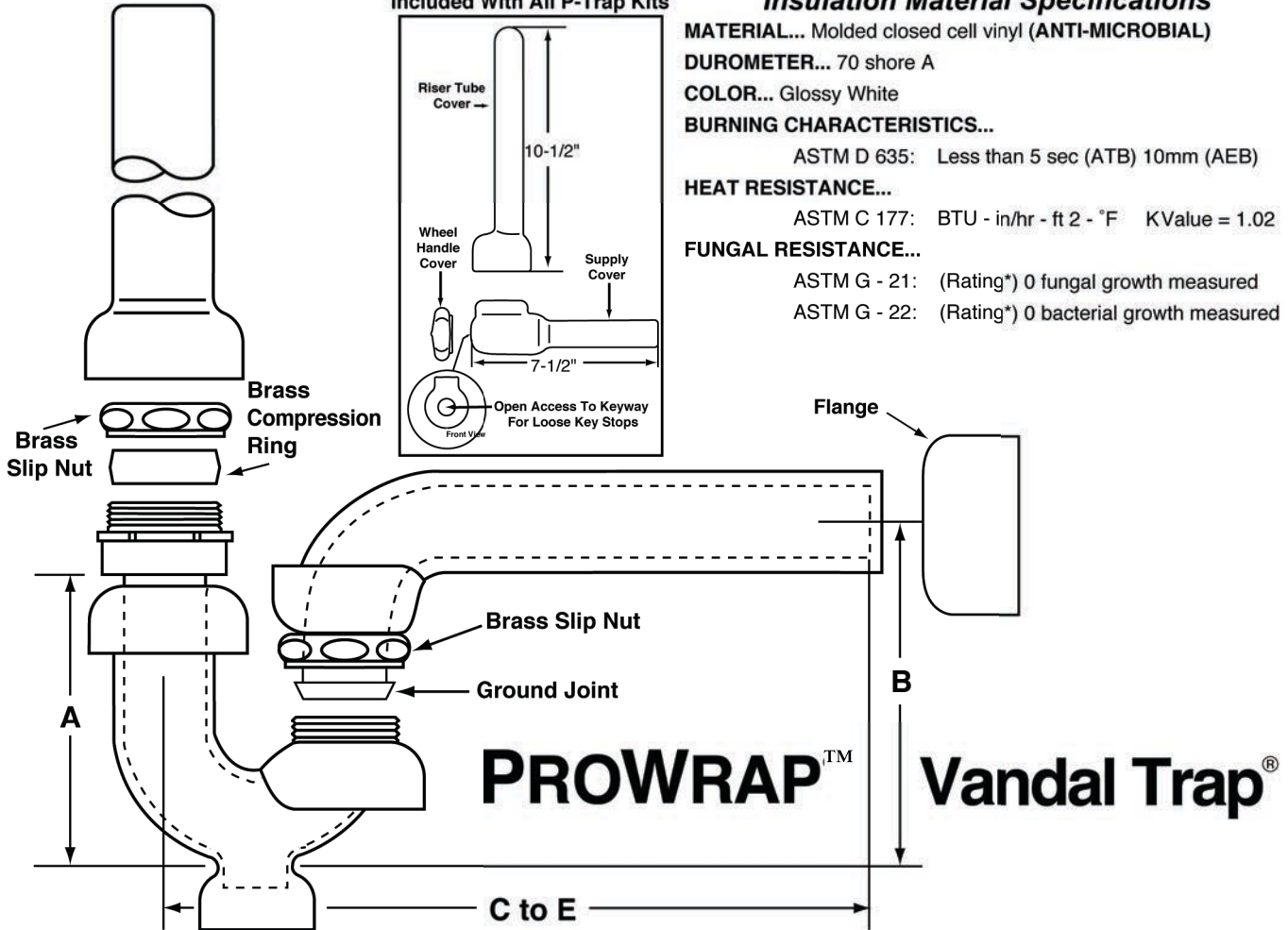

*ASTM Rating - Observed Growth on Specimens

- 0 None
- 1 Traces of Growth (less than 10%)
- 2 Light Growth (10-30%)
- 3 Medium Growth (30-60%)
- 4 Heavy Growth (60%-complete coverage)

Environmental Controls:

Paper - 4, Cork - 1, Cotton - 4, Glass - 0

ROUGHING MEASUREMENTS

NO.	DESCRIPTION	A	B	C to E
PWV8902	1-1/4" Inlet x 1-1/2" - 17 G.A.	5-1/2"	4-3/8"	12"
PWV8912	1-1/2" Inlet x 1-1/2" - 17 G.A.	5-1/2"	4-3/8"	12"

* Note: Rough-In from wall must be 1-1/2" MALE IPS.

V8902 and V8912 is ASME
 A112.18.2/CSA B125.2



A.D.A.



See options and accessories section for details on product variations.

Specifications:

Seamless PreWrapped Adjustable Cast Brass P-Trap Kit furnished with McGuire's Vandal Trap®, Vandal Resistant P-Trap with cleanout, seamless supply riser tube covers, supply angle stop covers, angle stop wheel handle covers and deep box flange.

WARNING:

This product can expose you to chemicals including lead, which is known to the State of California to cause cancer, and birth defects or other reproductive harm. For more information go to www.P65Warnings.ca.gov.



McGuire Manufacturing Co., Inc.

60 Grandview Court
 Cheshire, Connecticut 06410
 (203) 699-1801 Fax (203) 699-1813
 customerservice@mcguiremfg.com mcguiremfg.com

PRODUCT SPECIFICATION

Part No.

**PWV8902NCO,
 PWV8912NCO**

**Seamless PreWrapped
 Cast P-Trap Insulation Kit
 Vandal Resistant**

Job Name:

Submittal Number:

**Supply Covers (1 pair)
 Included With All P-Trap Kits**

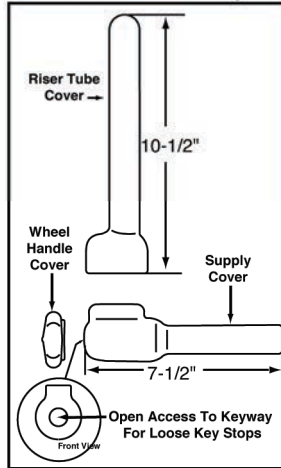

Insulation Material Specifications

MATERIAL... Molded closed cell vinyl (ANTI-MICROBIAL)
DUROMETER... 70 shore A
COLOR... Glossy White
BURNING CHARACTERISTICS...
 ASTM D 635: Less than 5 sec (ATB) 10mm (AEB)
HEAT RESISTANCE...
 ASTM C 177: BTU - in/hr - ft 2 - °F KValue = 1.02
FUNGAL RESISTANCE...
 ASTM G - 21: (Rating*) 0 fungal growth measured
 ASTM G - 22: (Rating*) 0 bacterial growth measured

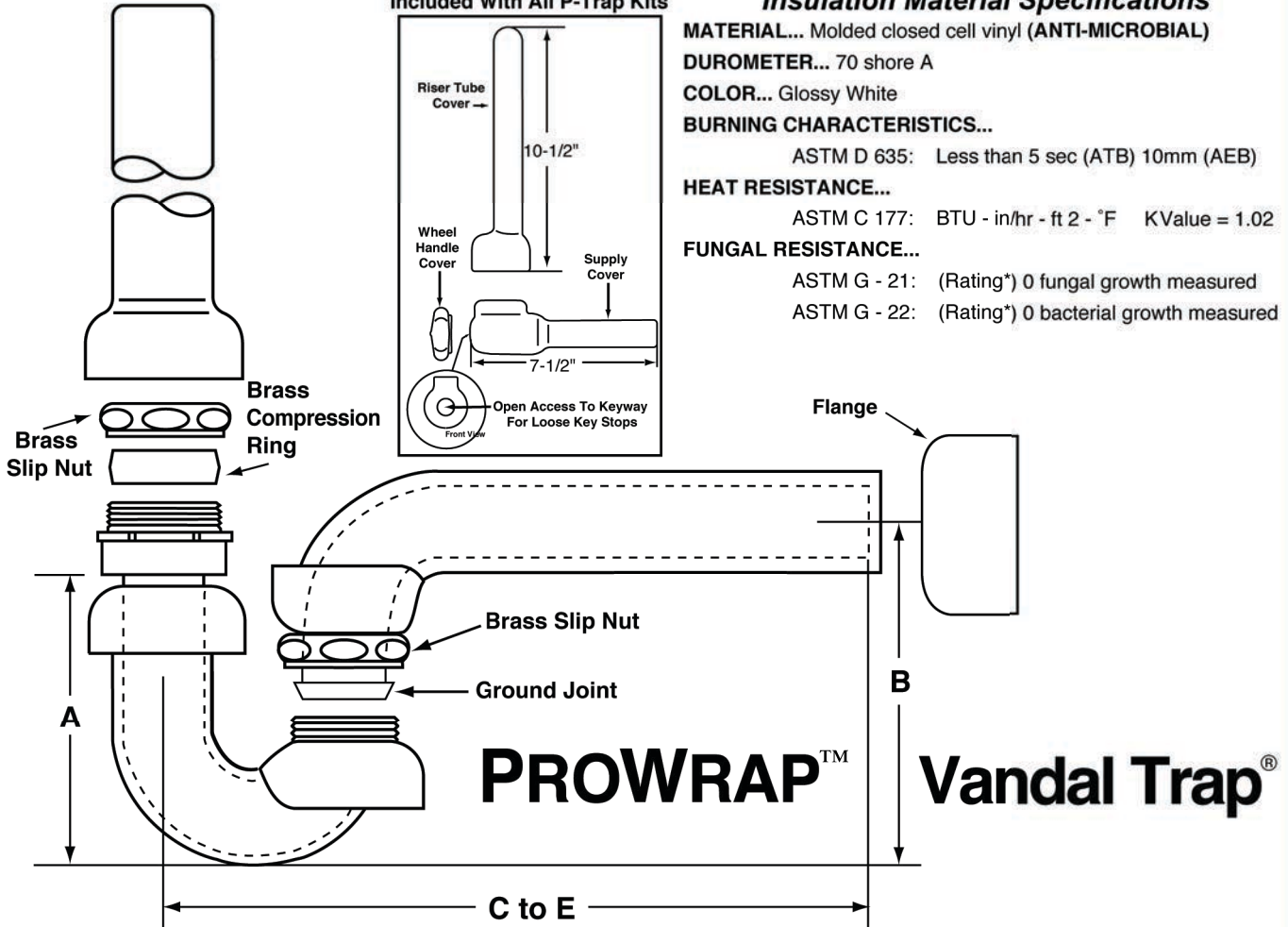

*ASTM Rating - Observed Growth on Specimens

- 0 None
- 1 Traces of Growth (less than 10%)
- 2 Light Growth (10-30%)
- 3 Medium Growth (30-60%)
- 4 Heavy Growth (60%-complete coverage)

Environmental Controls:

Paper - 4, Cork - 1, Cotton - 4, Glass - 0

ROUGHING MEASUREMENTS

NO.	DESCRIPTION	A	B	C to E
PWV8902NCO	1-1/4" Inlet x 1-1/2" - 17 G.A.	5-1/2"	4-3/8"	12"
PWV8912NCO	1-1/2" Inlet x 1-1/2" - 17 G.A.	5-1/2"	4-3/8"	12"

* Note: Rough-In from wall must be 1-1/2" MALE IPS.

A.D.A.



See options and accessories section for details on product variations.

Specifications:

Seamless PreWrapped Adjustable Cast Brass P-Trap Kit furnished with McGuire's Vandal Trap®, Vandal Resistant P-Trap without cleanout, seamless supply riser tube covers, supply angle stop covers, angle stop wheel handle covers and deep box flange.

WARNING:

This product can expose you to chemicals including lead, which is known to the State of California to cause cancer, and birth defects or other reproductive harm. For more information go to www.P65Warnings.ca.gov.



McGuire Manufacturing Co., Inc.

60 Grandview Court
 P.O. Box 746 • Cheshire, CT 06410
 203-699-1801 • Fax: 203-699-1813
 www.mcguiremfg.com

PRODUCT SPECIFICATION

Part No.

PW155HDWC

**Seamless PreWrapped Heavy
 Duty Offset Lavatory Strainer**

Job Name:

Submittal Number:

**Seamless PreWrapped
 Lavatory Strainer Insulation**

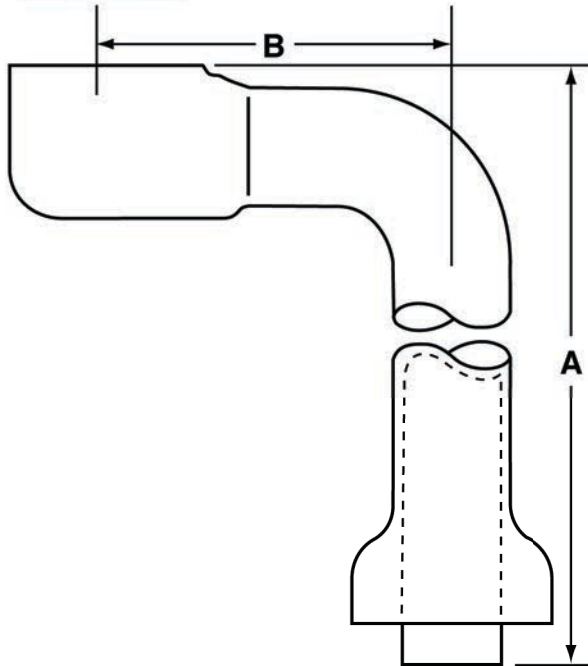
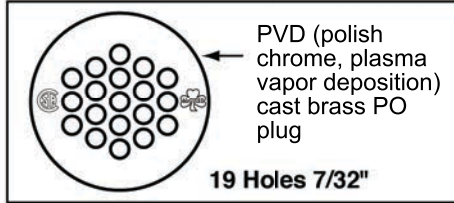

PROWRAP®

Insulation Material Specifications

- MATERIAL...** Molded closed cell vinyl (ANTI-MICROBIAL)
- DUROMETER...** 70 shore A
- COLOR...** Glossy White
- BURNING CHARACTERISTICS...**
 - ASTM D 635: Less than 5 sec (ATB) 10mm (AEB)
- HEAT RESISTANCE...**
 - ASTM C 177: BTU - in/hr - ft 2 - °F KValue = 1.02
- FUNGAL RESISTANCE...**
 - ASTM G - 21: (Rating*) 0 fungal growth measured
 - ASTM G - 22: (Rating*) 0 bacterial growth measured

***ASTM Rating - Observed Growth on Specimens**

- 0 None
- 1 Traces of Growth (less than 10%)
- 2 Light Growth (10-30%)
- 3 Medium Growth (30-60%)
- 4 Heavy Growth (60%-complete coverage)

Environmental Controls:

Paper - 4, Cork - 1, Cotton - 4, Glass - 0

ROUGHING MEASUREMENTS

MODEL NO.	DESCRIPTION	A	B
PW155HDWC	1-1/4" - 17 G.A. - Lavatory Offset	8-3/4"	5-1/8"

A.D.A.



MADE IN USA
 U.S. PATENT
 5,341,830 5,586,568
 5,904,175 5,911,237
 5,795,623 5,678,598

See options and accessories section for details on product variations.

Specifications:

Seamless prewrapped heavy duty offset lavatory strainer for ADA compliance. Furnished with PVD chrome plated brass lavatory grid strainer and 17 gauge prewrapped seamless offset brass tailpiece.

! WARNING:

This product can expose you to chemicals including lead, which is known to the State of California to cause cancer, and birth defects or other reproductive harm. For more information go to www.P65Warnings.ca.gov.